

Varenummer: 203380M20150B1U

Beskrivelse: E+G Justerfod
GN 33-80-M20-150-B1-U, Rustfast

Note: U Uden møtrik, sekskant i toppen, spændeflade i bunden

Mål

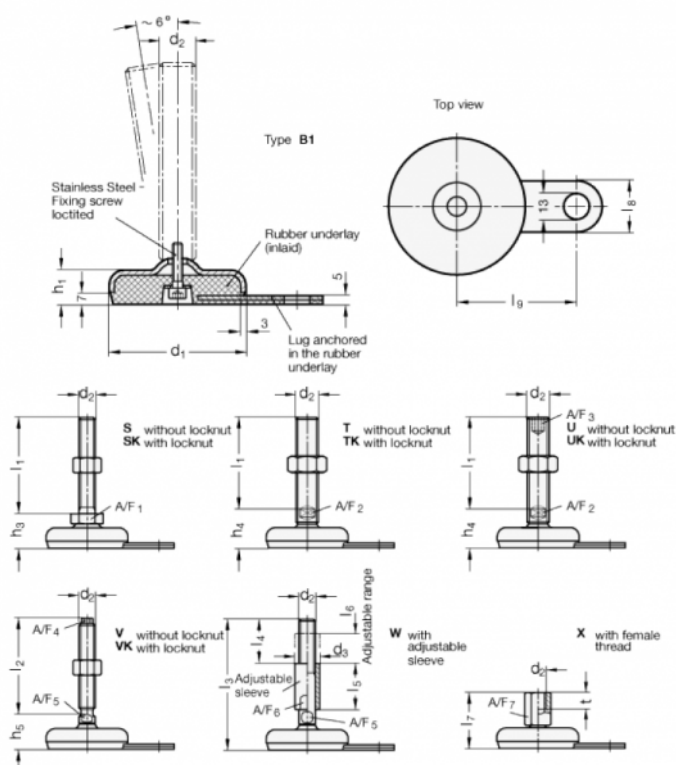

A/F2 = 15

I9 = 70

A/F3 = 10

d1 = 80

d2 = M20

h1 = 18

h3 = 35

l1 = 150

l8 = 30